 **ALFABETIZAÇÃO**
BOQUINHAS PARA CRIANÇAS COM
AUTISMO

J/GE-GI - S/SS/CE-CI/Ç - X/CH - Z/ASA - H - CH/LH/NH

Camille Mouraⁿ

Re ata Jardini

Viviani Guimarães



MATERIAL ESTRUTURADO

**Camille Moura Palma
Renata Savastano R. Jardini
Viviani Guimarães**

**Alfabetização
Boquinhos para
Crianças com Autismo
Volume 5:
J/GE-GI - S/SS/CE-CI/Ç
- X/CH - Z/ASA -
H - CH/LH/NH
Material Estruturado**

Método fonovisuoarticulatório

Boquinhos Aprendizagem e Assessoria



Bauru
2024

Boquinhos Aprendizagem e Assessoria

Copyright © 2014 by Boquinhos Aprendizagem e Assessoria Ltda

Rua Olavo Bilac 2-40 - 17.060-454 - Bauru/SP

Telefone: (21) 98593.0254

e-mail: contato@metododasboquinhos.com.br

home-page: <http://www.metododasboquinhos.com.br>

Impresso no Brasil/Printed in Brazil, com depósito legal na Biblioteca Nacional conforme Decreto n 1.825, de 20 de dezembro de 1907. Todas as informações, exercícios, dados, conteúdo e materiais que compõe o "Método das Boquinhos" integram o patrimônio intelectual da empresa Boquinhos Aprendizagem e Assessoria Ltda, regularmente protegidos e resguardados pelo ordenamento jurídico nacional e internacional, possuindo ainda registro de marca, direito autoral e respaldado pelas regras que vedam a concorrência desleal, sendo terminantemente proibida a sua reprodução, comercialização, disponibilização, publicação, adaptação ou, ainda, qualquer outra forma de exploração. A violação dos direitos de autor (Lei n 5.988/73) é crime estabelecido pelo artigo 184 do Código Penal.

Editor responsável: Renata Jardini

Diagramação: Criative Publicidade e Editoração

Capa: Viviani Guimarães

Modelo das boquinhos: Cecília Cartes

Revisão: Renata Jardini e Viviani Guimarães

Dados Internacionais de Catalogação na Publicação (CIP)
(Câmara Brasileira do Livro, SP, Brasil)

Dados Internacionais de Catalogação na Publicação (CIP)
(Câmara Brasileira do Livro, SP, Brasil)

Moura, Camille
Alfabetização boquinhos para crianças com autismo
: volume 5 [livro eletrônico] : J/Ge-Gi -
S/Ss/Ce-Ci/Ç - X/Ch - Z/Asa - H - Ch/Lh/Nh : material
estruturado / Camille Moura, Renata Jardini, Viviani
Guimarães. -- Bauru : Boquinhos Aprendizagem e
Assessoria Ltda, 2024.

PDF

ISBN 978-65-87356-20-4

1. Alfabetização 2. Crianças com distúrbios da
aprendizagem 3. Deficiência intelectual
4. Fonoaudiologia 5. Método das boquinhos
6. Psicologia da aprendizagem 7. Vida familiar -
Educação I. Jardini, Renata. II. Guimarães, Viviani.
III. Título

24-196705

CDD-370.15

Índices para catálogo sistemático:

1. Dificuldades e distúrbios de aprendizagem :
Psicopedagogia 370.15

SUMÁRIO

	AUTISMO	AGRADECIMENTOS	06
	AUTISMO	APRESENTAÇÃO	07
	AUTISMO	INFORMAÇÕES SOBRE OS EXERCÍCIOS	09
	AUTISMO	A BOQUINHA  E SUAS LETRAS	11
	AUTISMO	ANTÔNIMO	23
	AUTISMO	A BOQUINHA  E SUAS LETRAS	27
	AUTISMO	S INICIAL	29
	AUTISMO	_SS_	35
	AUTISMO	AS LETRAS C E Ç	40
	AUTISMO	MASCULINO E FEMININO	47
	AUTISMO	A LETRA X E O DÍGRAFO CH	49
	AUTISMO	CONFRONTO J-GE-GI E X-CH	59



AUTISMO

A LETRA Z - ASA 64



AUTISMO

CONFRONTO ASA E ASSA 71



AUTISMO

A LETRA H 73



AUTISMO

OS DÍGRAFOS CH, LH, NH 76



AUTISMO

DIMINUTIVO 82



AUTISMO

ATIVIDADES ADAPTADAS 84



AUTISMO

BRINCADEIRAS 88



AUTISMO

ANEXO 1 91



AUTISMO

ANEXO 2 - SÍLABAS 94



AUTISMO

ANEXO 3 - ETIQUETA ACABOU 140

DEMO BOQUINHAS APENAS VISUALIZAÇÃO

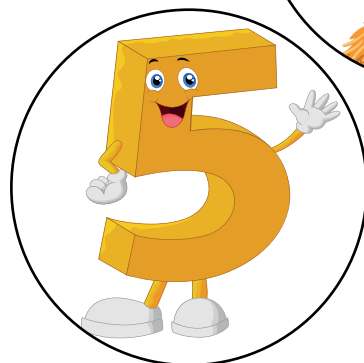
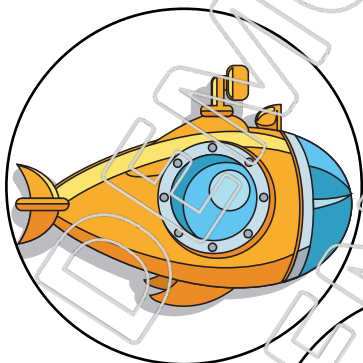
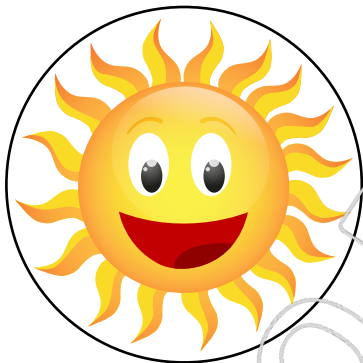
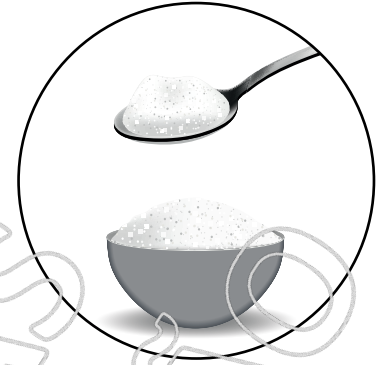



PA

SO



SU

CO

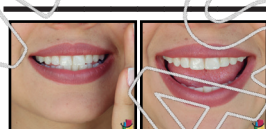

REI

SE

A

[Empty box for a word]

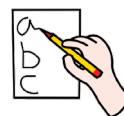
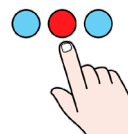

3. Marque a resposta correta e depois escreva a palavra.



	
PÊSSEGO	
S	SS
	

	
SORVETE	
S	SS
	

	
SAPATO	
S	SS
	

	
SOPA	
S	SS
	

--



EXERCÍCIO

1. Complete com a letra correta.



C	Ç
ON <u> </u>	A

C	Ç
PO <u> </u>	O

C	Ç
<u> </u> ENOURA	

C	Ç
CAL <u> </u>	A

2. Forme as palavras com CE - CI ou Ç, escrevendo a palavra na ordem da cor de cada sílaba.



LHA

PA

ÇO

A

CI

BA

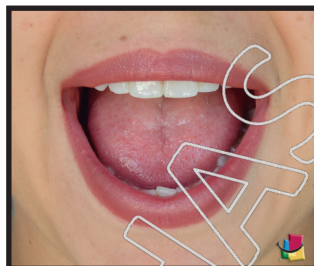
**MASCULINO / FEMININO****O, OS, UM, UNS****A, AS, UMA, UMAS****EXERCÍCIO****1. Recorte as figuras e coloque no local certo.****AVIÃO****BOLA****MAÇÃ****CARRO****CAMINHÃO****ALICATE****BOLSA****CAPACETE****PANELA****CANETA****LÁPIS****MOCHILA**